



OB

MESSER SOFT

MESSER 
Cutting Systems

OmniBevel 2021

Best-in-class technology for bevel cutting

OmniBevel 2021 is the professional software product for bevel cutting. It represents straight cuts, cylindrical holes, exact bevel angles and parts with absolute dimensional accuracy. The application is also characterized by enormous flexibility. Almost all possible technology parameters and operation details can be adjusted. The intelligent defaults based on the technology database often render any manual intervention redundant. This ensures efficient operations whilst meeting the highest quality standards.

OPTIMUM HARMONIZATION, PRECISE INSTRUCTIONS

To achieve quality bevel cuts, the NC code generated must match exactly the capabilities and performance of the machine used. Lateral and angular offsets must be considered for all cuts. Lead-ins and lead-outs as well as joining macros between individual contour areas must be placed in such a way that no damage to the contours occurs. Bevel cuts make the highest demands on the programming of the cutting plan.

MAKES THE MOST OF YOUR MACHINE

OmniBevel 2021 is a postprocessor module with graphical user interface. It inserts bevel information and technological requirements into NC plans in such a manner that the machine used gives optimum cutting results in automatic operation. With OmniBevel 2021 you are using the tool which will guarantee you the best quality when bevel cutting. OmniBevel 2021 brings out everything possible from your machine with a bevel unit.

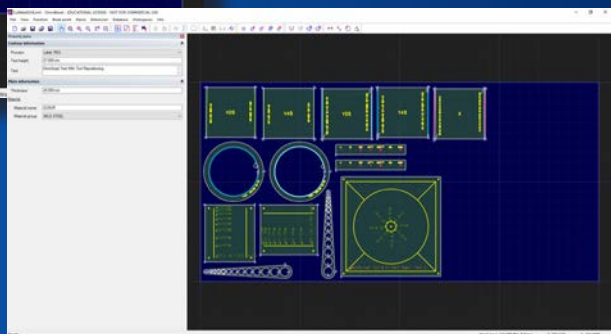
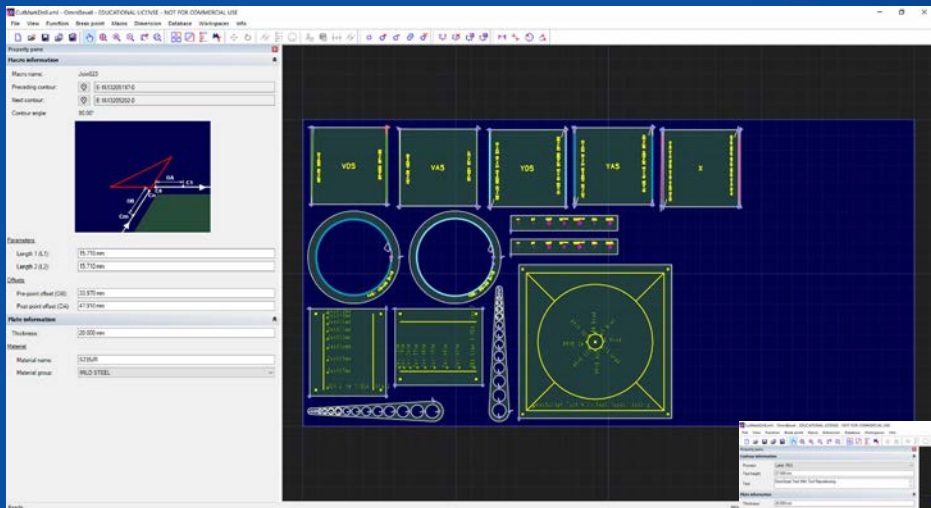
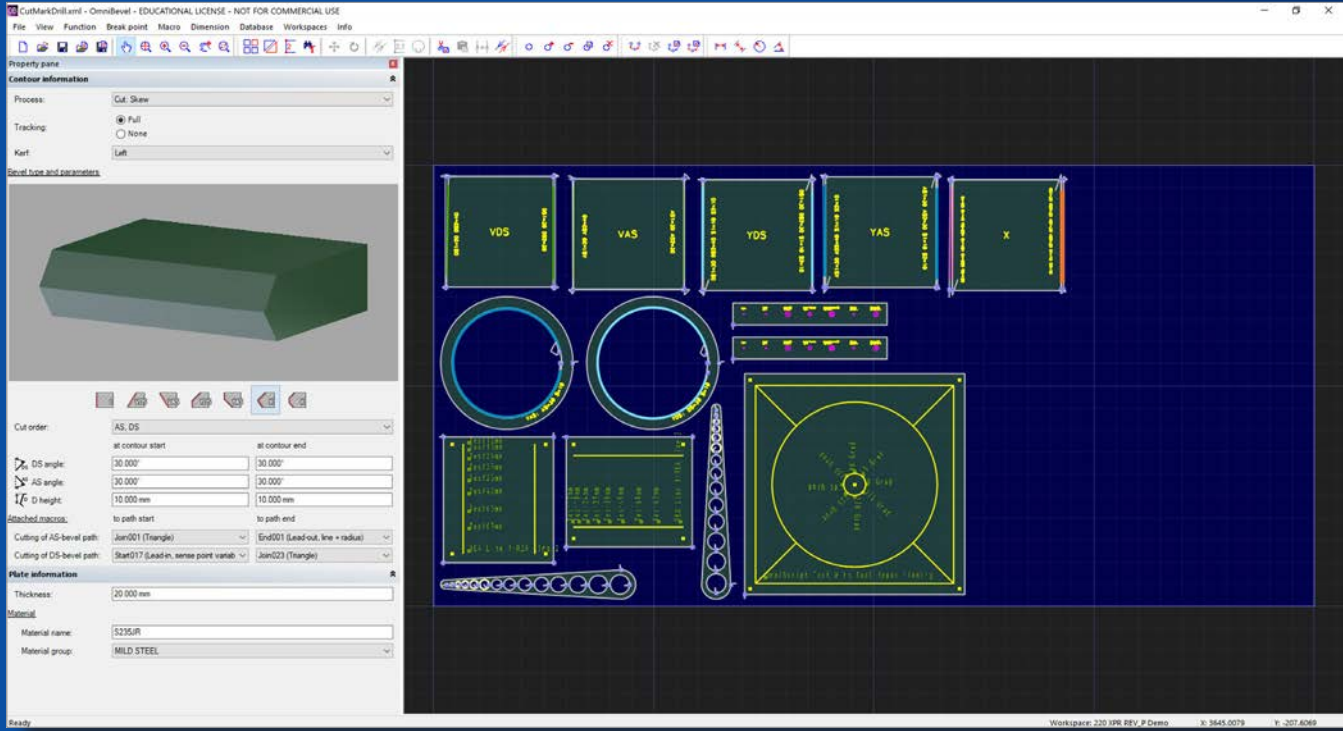

TECHNOLOGY AT IT'S BEST

NUMEROUS IMPORT FUNCTIONS

Import your nesting plans from OmniWin 2021 into OmniBevel 2021 using an open extended ESSI format. Connect OmniBevel 2021 to almost every nesting software from a third party supplier with the help of the highly flexible and adjustable import filters.

The highest flexibility that OmniBevel provides will convince you during the further processing of your nesting plan. If the imported nesting plans already contain bevel information, it will be taken over. In addition, you can complete or modify bevel information interactively, set break points or remove them and set the starting point for a contour.

SIMPLE OPTIMIZATION OF NESTING PLANS

Remove unwanted lead-ins or lead-outs from the original nesting system. You can define individually the sequence of cutting sub-contours and the sequence of individual cuts where, due to the sub contour's bevel, multiple cuts are needed (for units with one torch). Parts can be shifted or rotated. You decide for which circular holes with plasma cutting Messer Hole Technology (which includes Hypertherm's True Hole and Kjellberg's Contour Cut) is to be used, to produce cylindrical holes with the highest quality.

In addition you can define Plow bolt holes for plasma cutting and cylindrical holes. OmniBevel 2021 applies the required technology automatically.

TECHNOLOGY DATABASES, POSTPROCESSORS AND EXPORT OF NESTING PLANS

TECHNOLOGY DATABASES AND POSTPROCESSORS

The scope of supply of OmniBevel 2021 includes technology databases and postprocessors for numerous bevel cutting units. Whether a unit is technically suitable for an individual bevel type depends upon the unit itself. The limitations placed by the machine manufacturer concerned have to be respected.

EXPORT OF NESTING PLANS AND DEFINABLE WORKING AREAS

The technological characteristics of the optimized parts can be easily transferred onto other identical parts in the nesting plan. Then the nesting plan export into NC code is run. This is done using the postprocessor selected which will take account of specific lateral and angular compensations which may be necessary.

Simplify your daily work with OmniBevel 2021 by using defined working areas. Then all important parameters for the generation of specific bevel nesting plans can be called up again simply. Intermediate results can be saved at any time in the form of XML files.

OmniBevel 2021: One command will allow the entire nesting plan to have lead-in and lead-out lines as well as joining macros added automatically on the basis of the technology database selected and the machine specific postprocessor. These objects can also be individually inserted or deleted manually. The parameters can also be modified by hand at any time.

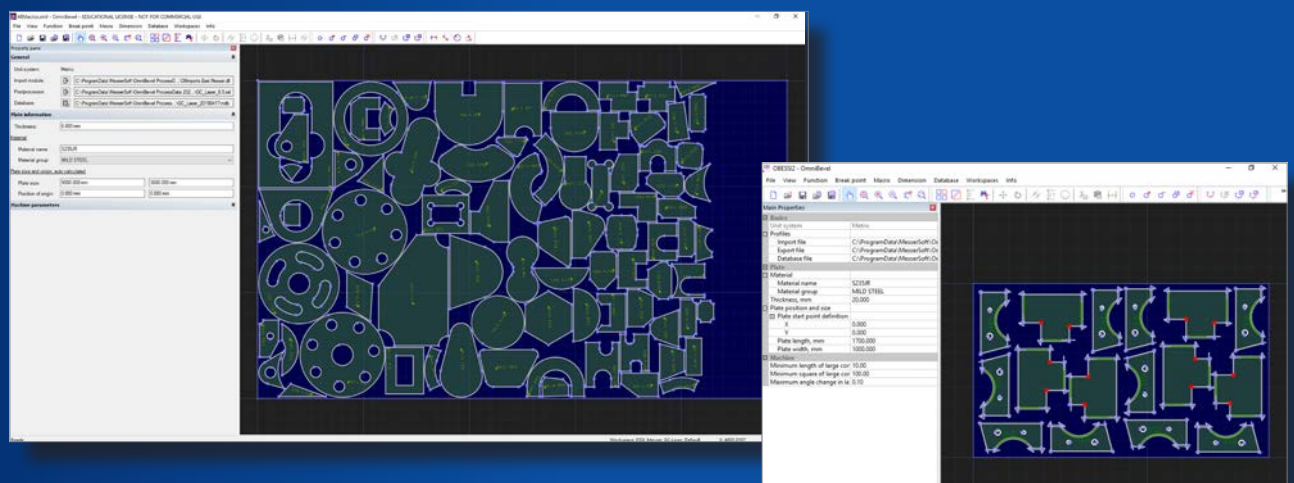
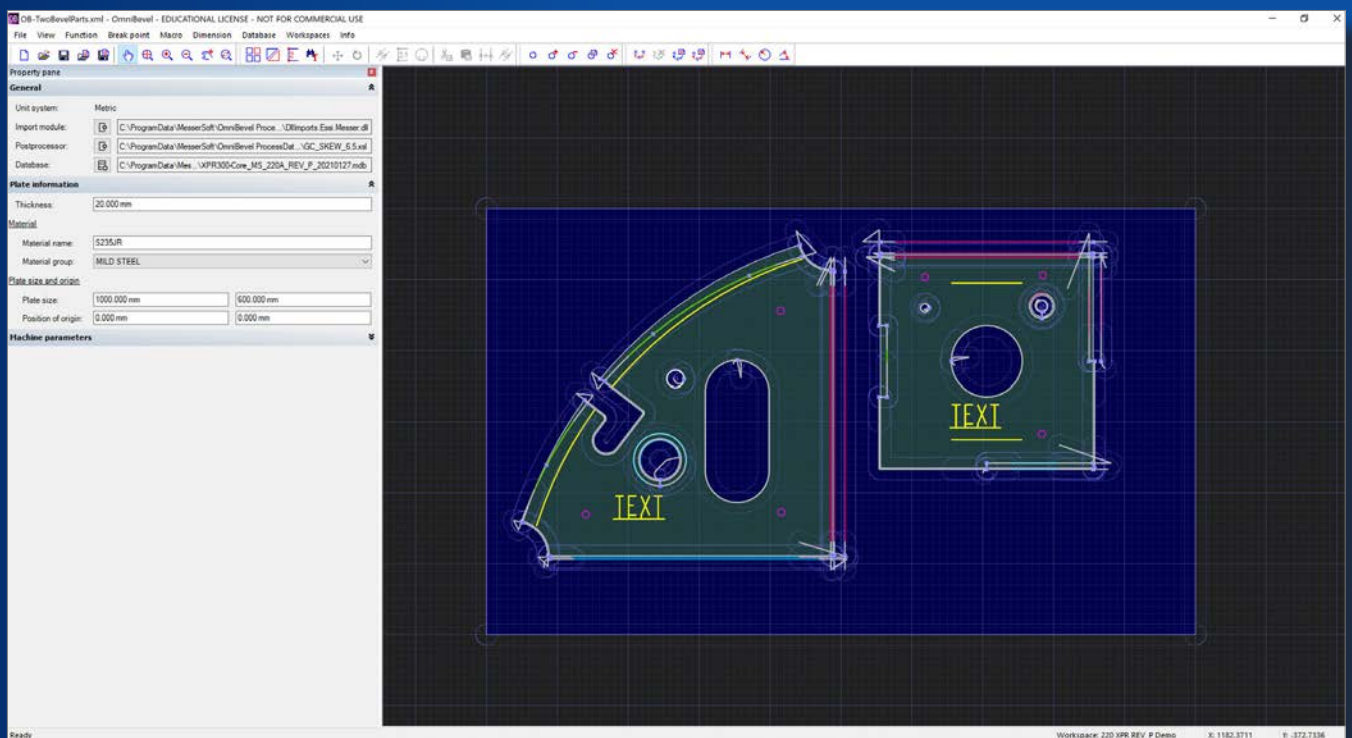

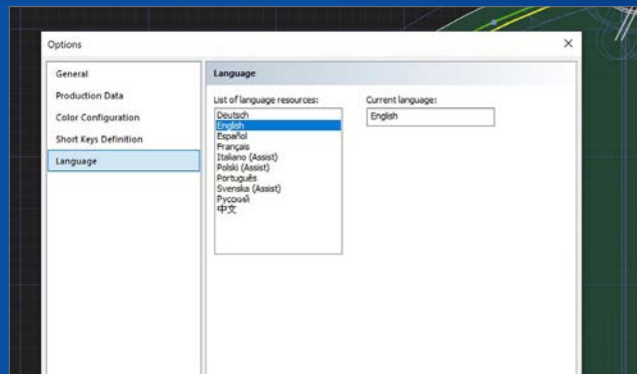
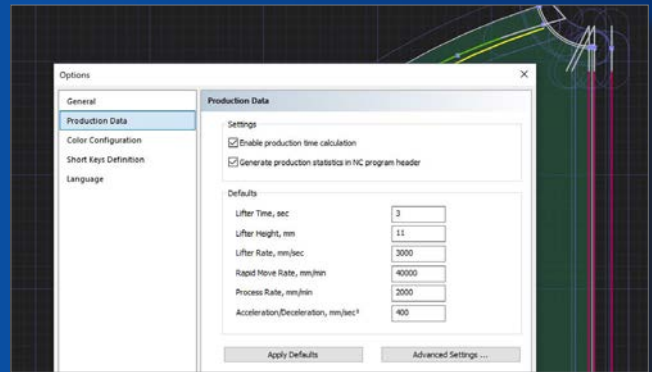
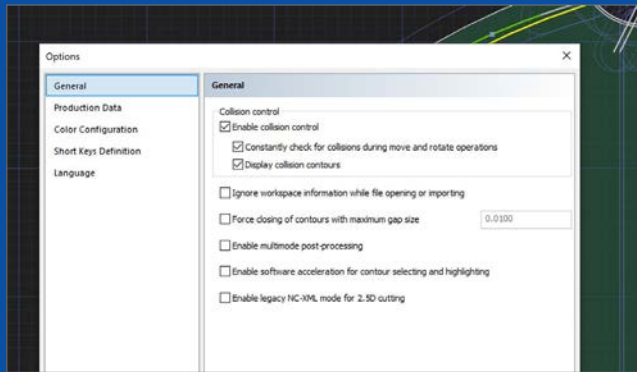
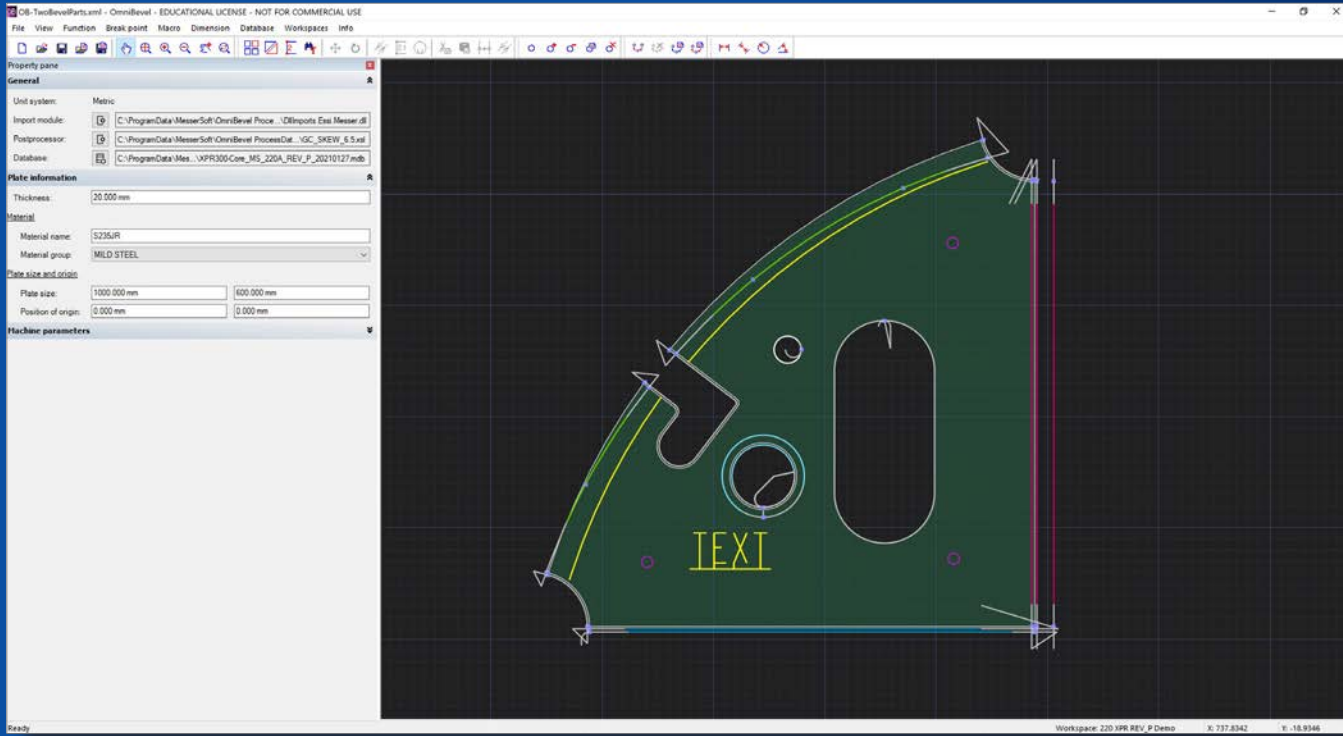

AUTOMATED PROCESSES

MARKING, DRILLING, TIME CALCULATION

Apart from the interactive mode, OmniBevel 2021 also offers an automatic “batch mode”, which can be called from the command line. Accordingly, the import, the insertion of the necessary technology and the export is all made in one step. All necessary parameters are taken over from the command line or the technology database. This process is particularly suitable for cutting shops specialized in particular components with repetitive production patterns and who wish to avoid interactive processing operations.

OmniBevel 2021 also supports marking tools such as Ink-Jets (REA/Imaje), punch markers, powder markers, OmniScript, plasma markers and laser marking. The drilling systems from Messer Cutting Systems are also supported. Here the drill information from the original nesting plan is displayed in the interface and transferred unaltered into the NC code.

OmniBevel 2021 offers an expert configuration for the integrated time calculation.

The intelligent postprocessor analyzes the NC code based on the stored configuration and calculates the expected production time based on this. The results are also displayed in the graphical user interface.

KOMBINED USE SIMPLE LICENSING

To perform part construction, nesting plan generation and bevel consideration in one common user interface, OmniWin 2021 with Option Bevel can be licensed as an alternative to licensing just OmniBevel 2021. As a result, you obtain the full integration of bevel nesting in the popular OmniWin nesting system. Automatic or interactive nesting is then made as for vertical edged parts. Bevel nesting plans no longer need to be reworked in the OmniBevel user interface.

All essential functionality including collision monitoring even for lead-ins and lead-outs and for joining macros is available in OmniWin. The NC code for the machine is then generated out of OmniWin, which uses the same process databases and postprocessors as OmniBevel 2021 does. When licensing OmniWin 2021 with Option Bevel, you additionally acquire the right to use the OmniBevel 2021 program.

Therefore an alternative workflow is supported, where you generate semi-complete nesting plans with OmniWin 2021 and subsequently transfer them to the OmniBevel interface to give the nesting plans a final polish there.

BATCH IMPORT/EXPORT

- Automatic import of nesting plans, use of technology parameters and export into target NC file in one step
- Can be called from the Windows command line

ALTERNATIVE LICENSING OF OMNIWIN 2021 WITH OPTION BEVEL

- User interface and all capabilities of OmniBevel 2021 can be used, too
- Use of the same databases and postprocessor technology
- Intermediate results can be taken over from OmniWin into the OmniBevel interface and processed further there

OmniBevel 2021 can be licensed and used in combination with OmniWin 2021 Option Bevel.

This includes special functionality that is not available in OmniWin 2021 Option Bevel.

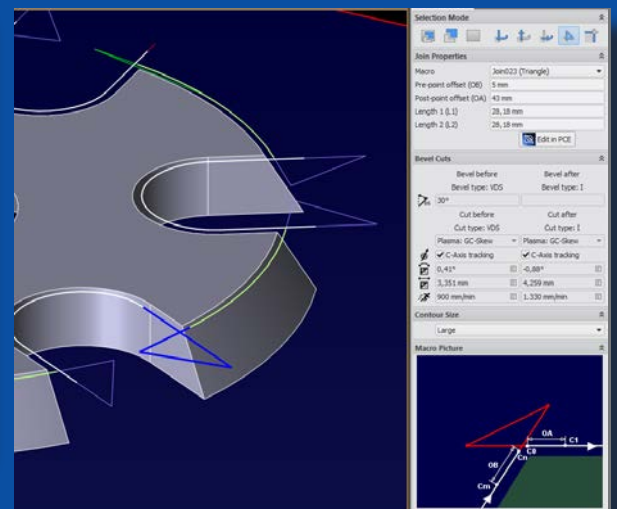
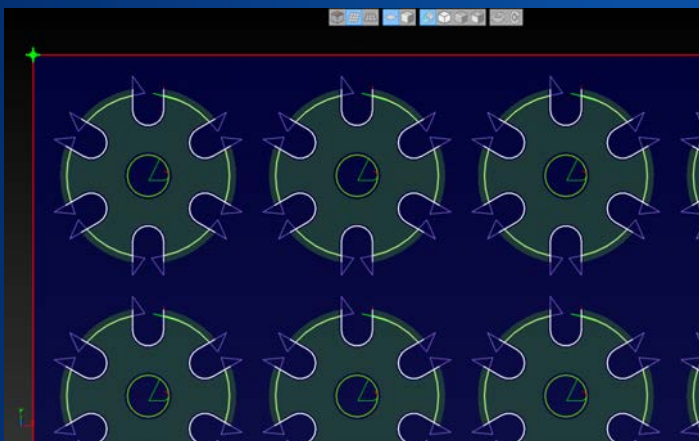
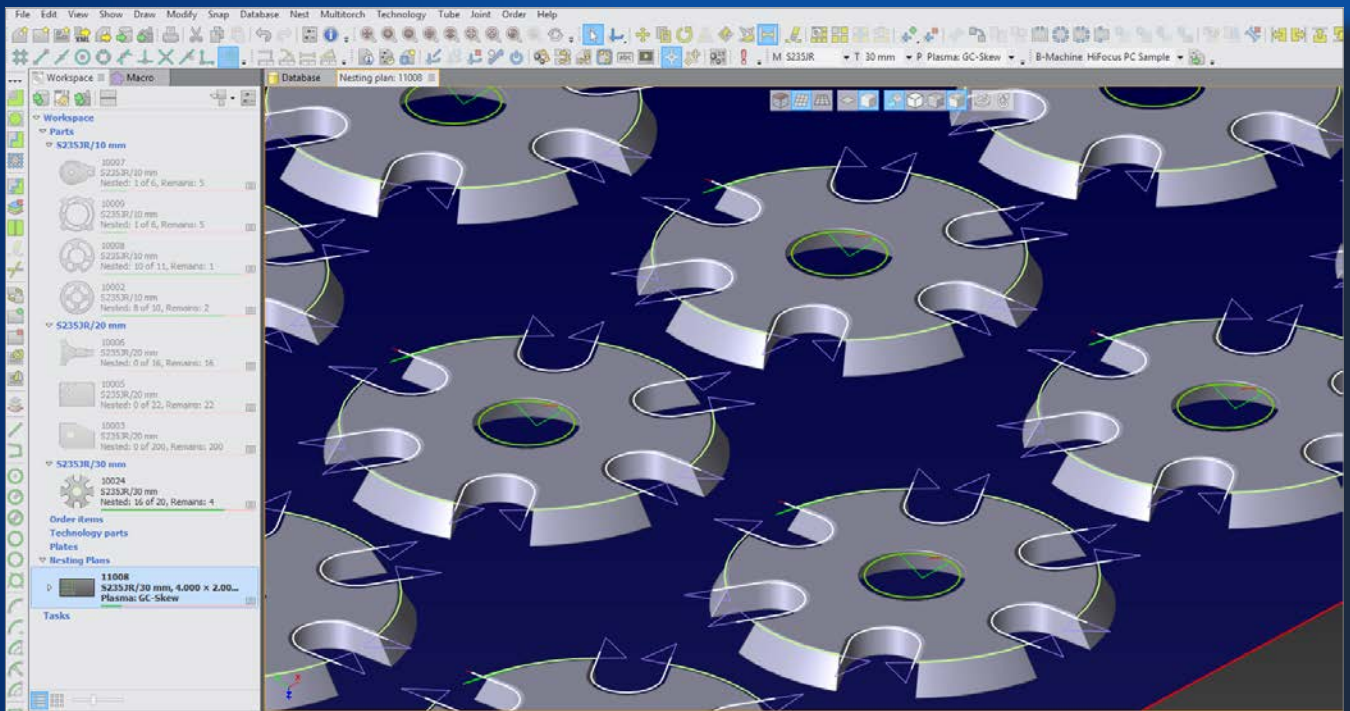

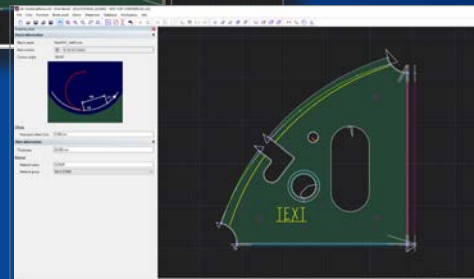
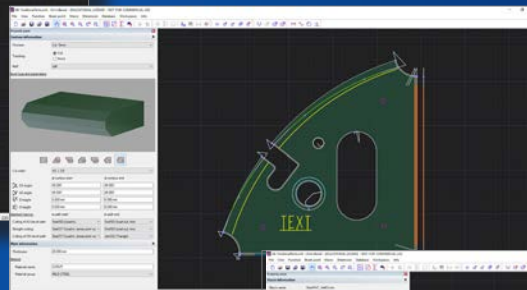
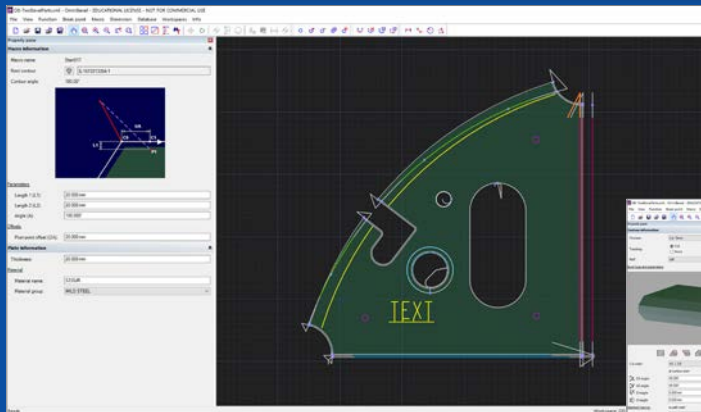
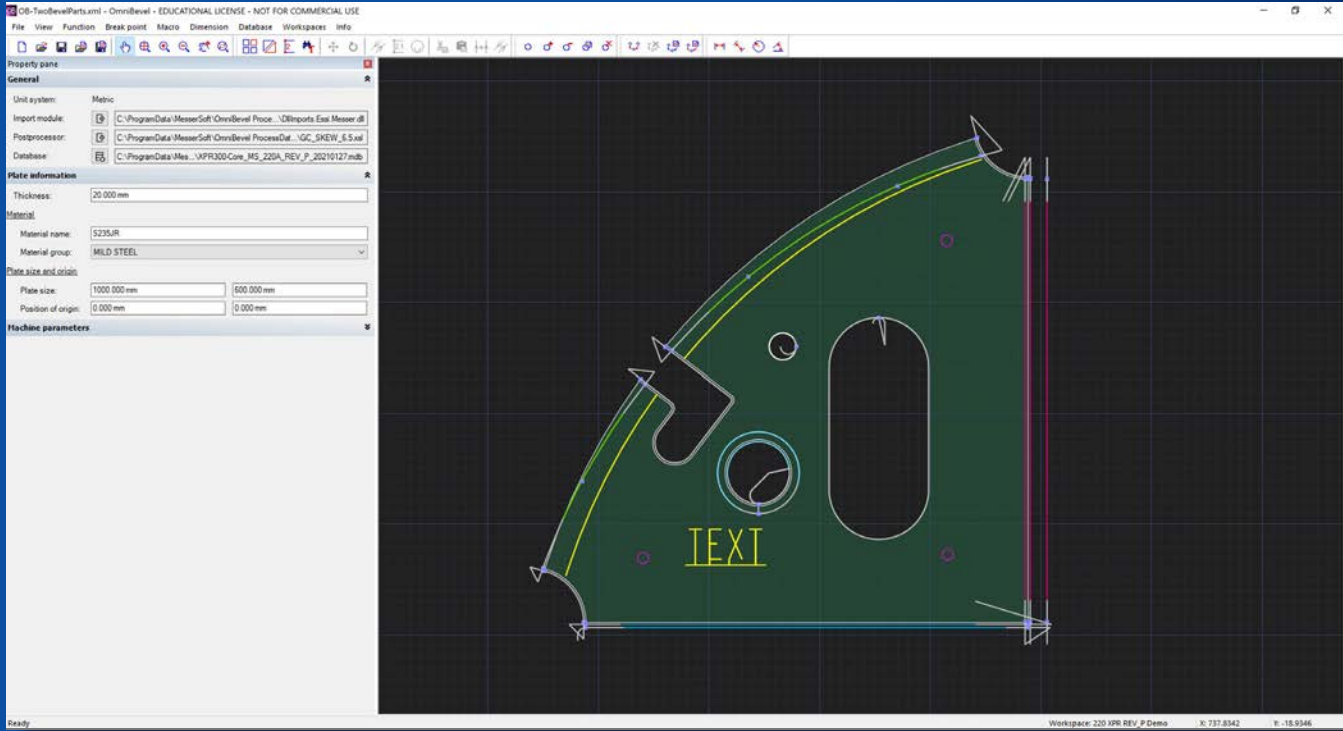

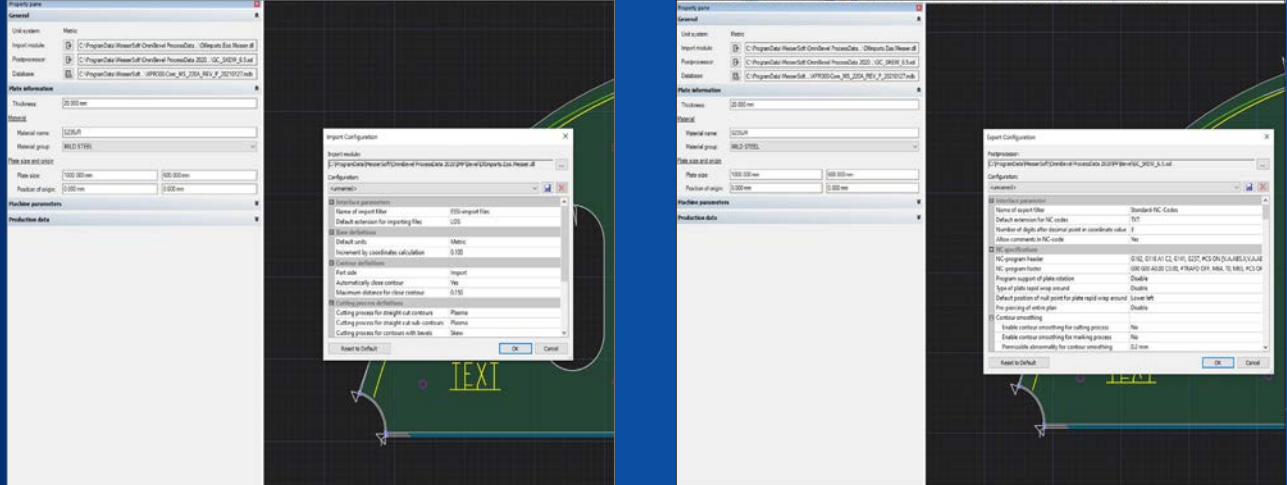

MAXIMUM FUNCTIONALITY FOR ALL PROCESSES

READING IN OF NC NESTING PLANS WITH THE AID OF DIVERSE IMPORT FILTERS

- Extended ESSI format for transfer from OmniWin 2021
- Import using ESAB ESSI (only I, VDS, VAS bevels), EIA,
- Project specific formats on the basis of QG, Tribon or Ship Constructor on request
- Process assignment to contours via import filter parameters
- Automatic setting of start points and break points, contour closing
- Evaluation of quality values on sub contours for direct assignment of different cutting processes with the import of Messer ESSI plans
- Disable contours

COMPREHENSIVE MACHINE SUPPORT

- Supports the cutting technologies Oxyfuel, Plasma and Laser
- Supports various marking tools such as punch marker, OmniScript, plasma marker, laser marking, Inkjet, sand / glass blasting, grinder
- Supports cutting machines with drilling heads in that drill information is transferred from the input side into the final NC output
- Export as DIN NC code via adaptable postprocessors
- Postprocessors with numerous parameters are included in the scope of supply, e.g. for plate rotation with plate position compensation

PLASMA

- Skew Rotator Infinity, Skew Rotator Delta
- Support of plasma power sources:
HyperTherm: HPR130XD - HPR400XD and XPR 300
Kjellberg: HiFocus 280i - 440i
- Cut repetitions for Y, X and K* bevels for plasma processes with one torch
- Lead-in, lead-out and corner technology for I, VDS, VAS, YDS, YAS bevels up to 45°
- Process databases** with theoretically calculated lateral and angular compensation values for I, VDS, VAS, YDS, YAS bevels up to 45° for Mild Steel (S235) and Stainless Steel (1.4301)
- Messer Hole Technology

OXYFUEL

- Units: D/AFL and D/KS
- Lead-in, lead-out and corner technology for I, VDS, VAS, YDS, YAS, X and K bevels up to 65°
- Process databases (Propane, Acetylene) with speed values

LASER

- Units: Bevel head for LaserMat, Bevel head for PowerBlade
- Lead-in, lead-out and corner technology for I, VDS, VAS, YDS bevels up to 50°
- Cut repetition for YDS bevels with one torch

* No guide values are supplied for X and K bevels. For these bevel types, individual correction values must be determined by the user, to obtain a highly repetitive accuracy when cutting.

** The supplied database structure makes it possible to produce bevel cuts with highly repetitive accuracy, using user provided correction values. The supplied guide values must be adjusted specifically for the materials used by the user.

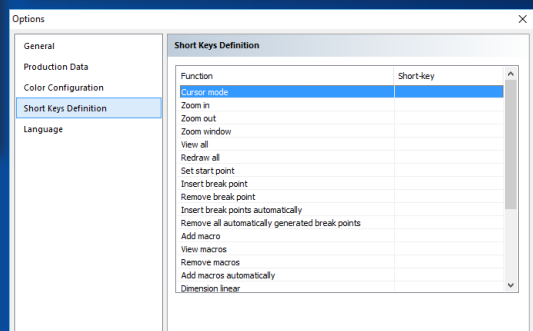
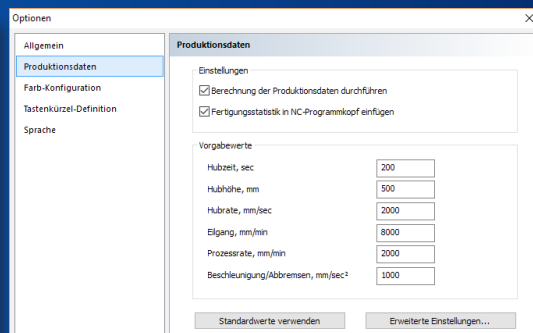
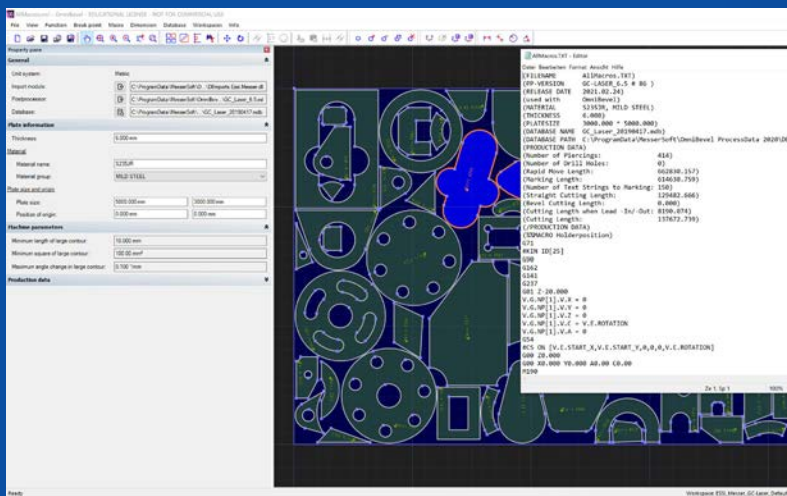
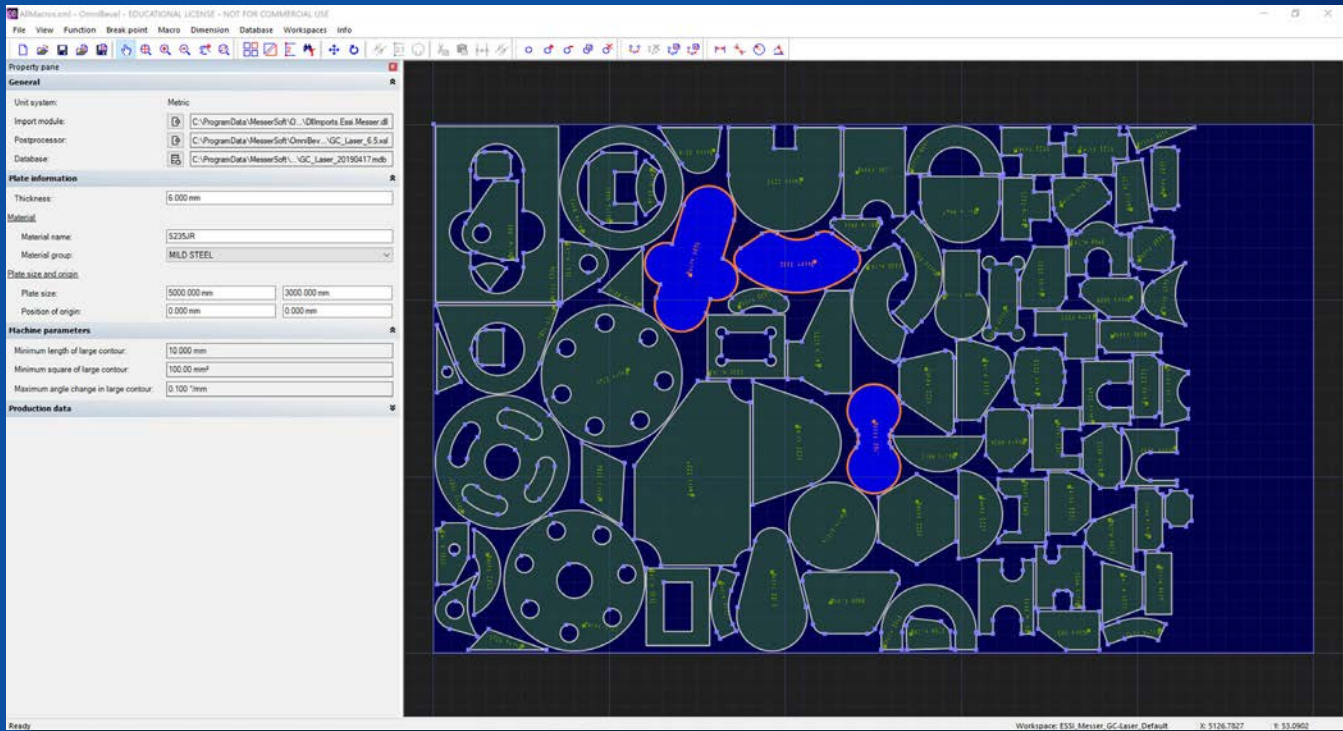

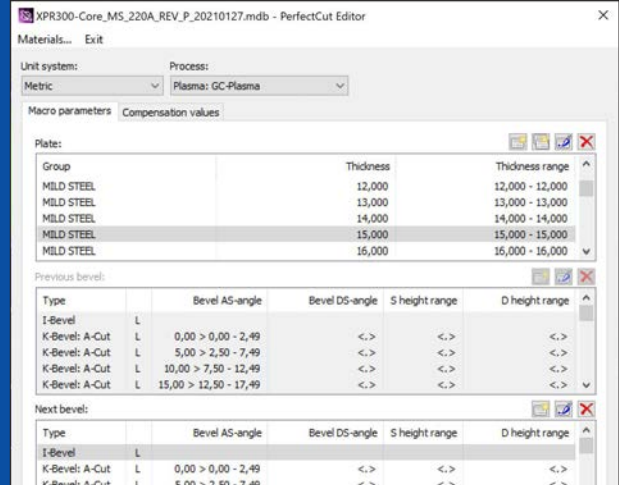
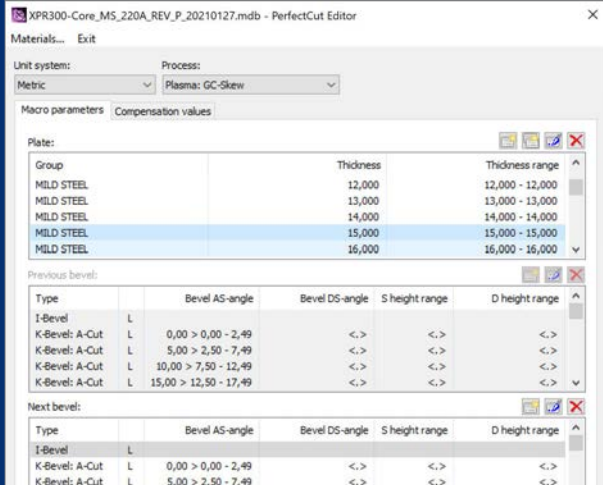

INTERACTIVE AND INTUITIVE SIMPLE OPERATION

USER-FRIENDLY INTERACTIVE PROCESSING OF THE BEVEL NESTING PLAN

- Automatic removal of existing lead-ins and lead-outs from the imported nesting plan
- Manual definition of start points
- Insertion and removal of break points for the definition of contour sections
- Modification/assignment of bevel characteristics on contour sections with 3D-preview
- Changing the direction of cut
- Moving and rotating parts
- Defining the tool path for the sequence of cuts for sub-contours
- Automatic creation of lead-ins and lead-outs, joining macros, contour offsets and repeat cuts according to the settings in the technology database
- Single or multi selection of macros
- Manual modification of lead-ins and lead-outs or joining macros
- Automatic collisions checks for outer contours after the placing of lead-ins and lead-outs or joining macros
- Auxiliary dimensioning of part geometries
- Replacement of text marking
- Copying/transferring of technology information from one part to identical parts

SIMPLE AND INTUITIVE INSTALLATION AND OPERATION

- Parallel installation with earlier version possible
- Menu guidance available in numerous languages
- Support of the metric (millimeter) and imperial (inch) measurement systems
- Support of several workspaces for simple changeover between various application scenarios
- Storing of completed and partly completed nesting plans as XML files for reuse later

ADDITIONAL PROJECT OPTIONS

PROJECT OPTION 2.5D

With the 2.5D Project Option, you can cut wind tower panels quickly and effectively with two torches. You get optimal interaction between postprocessor and machine.

- Simultaneous cutting with two torches of slightly different part contours (e.g. with plates for wind turbine towers)
- Includes the project specific adjustment of the postprocessor

PROJECT OPTION PANEL

The Project Option Panel offers everything that is required for the individual panel machine especially for shipbuilding.

- Fulfills the special requirements for shipbuilding
- Includes the project specific adjustment of the postprocessor

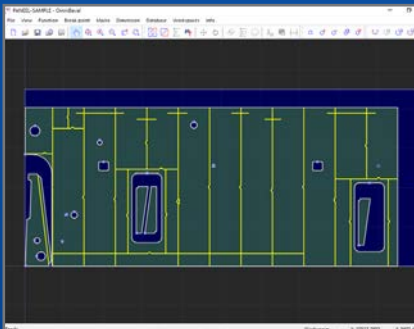
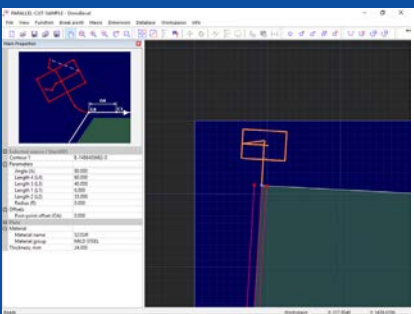
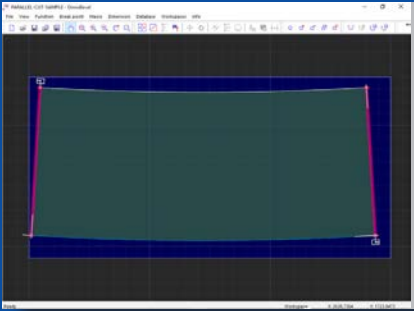



SYSTEM REQUIREMENTS AND CHARACTERISTICS

Hardware requirements

- 1 GB RAM, 4 GB hard disk space, 2 GHz CPU
- Minimum screen resolution 1280 x 960 px, recommended 1680 x 1050 px or more
- Graphics processor with OpenGL 1.1 support or higher, without „shared memory“
- USB port for connecting a local software protection dongle or network access to a license server

Supported operating systems

- Windows 7 32 bit or 64 bit
- Windows 8 32 bit or 64 bit
- Windows 10 32 bit or 64 bit

Software prerequisites

- Microsoft Internet Explorer Version 7 or higher
- Microsoft .NET Framework 4.0 or 4.5
- Microsoft Jet 4.0 SP4 or higher
- Microsoft Office Access database engine 2007

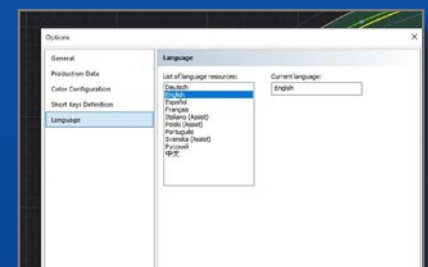
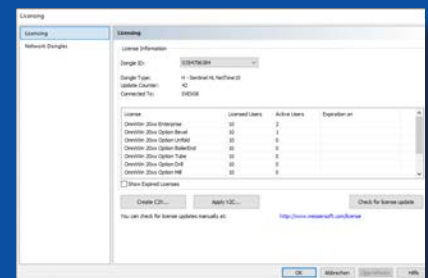
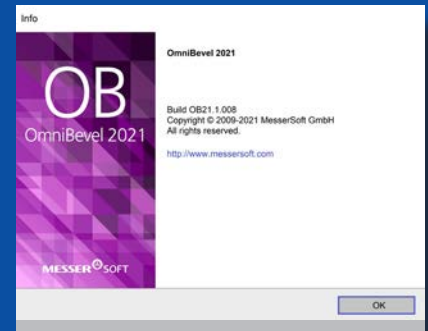



Messer Cutting Systems GmbH

Otto-Hahn-Str. 2-4
64823 Groß-Umstadt
T +49 6078 787-0
info@messer-cutting.com
www.messer-cutting.com